

The Chelsea Solid Brass Dimmable Step/Wall Light 3000K

The outside diameter of the uncompressed O-Ring is $\varnothing 40\text{mm}$. For a snug fit, your cutout hole diameter must match this or be slightly less, this will vary depending on your substrate. We recommend cutting a test hole in a similar material if a compressed O-Ring fit is required.

In some substrates, (such as concrete or stone), where a clean and accurate hole is challenging, a suitable sealant should be used in addition or in place of the O-Ring.

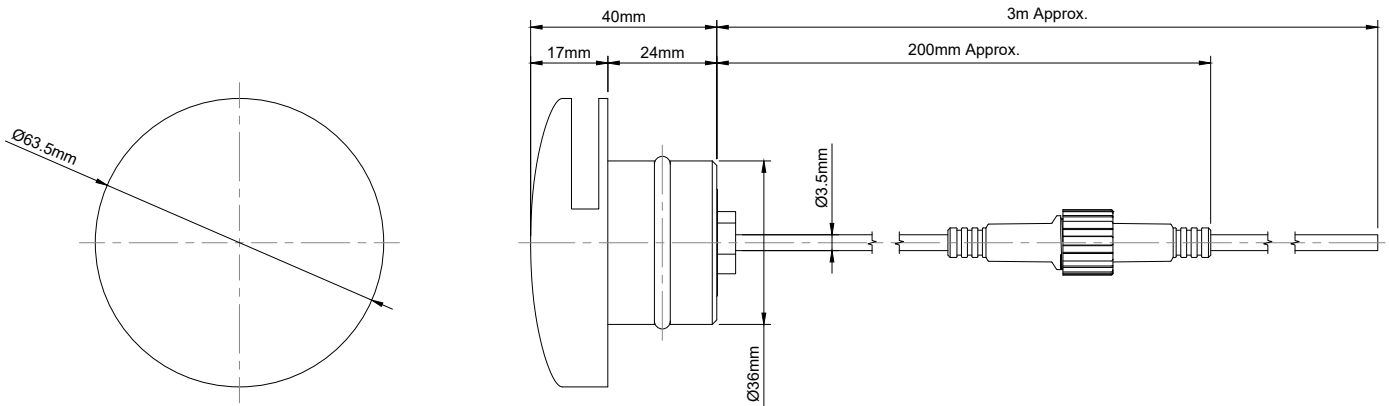
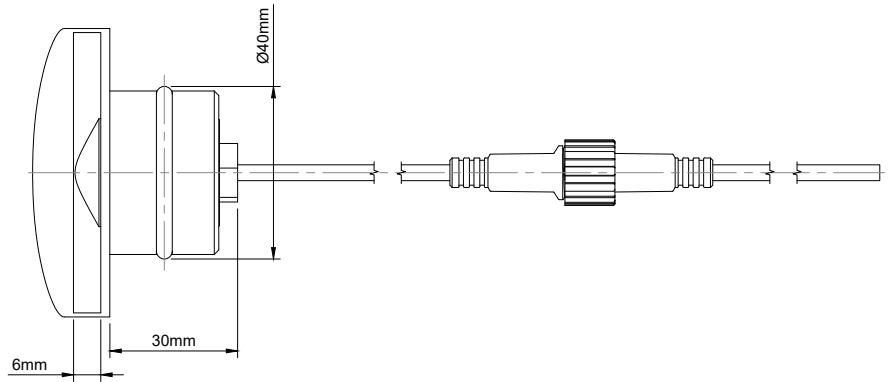

TECHNICAL DATA

50-STP001-RB3K	The Chelsea Solid Brass Dimmable Step/Wall Light 3000K
Material	Solid Machined Brass
Dimensions	$\varnothing 63.5\text{mm} \times 40\text{mm}$
Cutout Diameter	$\varnothing 40\text{mm}$ (See note on drawing above)
24V Light source	Fitted with Enkin 03-LEM001-30K LED module (Ref. page 2 for data)
Energy Efficiency Class	G
Driver	Not supplied
Driver type	Suitable SELV, 24V DC driver
Trademarks	The Soho Lighting Company is a registered trade mark number: UK00003313349, EU017906396, Date: 25 May 2018

POWERED BY



03-LEM001-30K or 40K

Enkin IP68 LED Dimmable Module (With Connector)

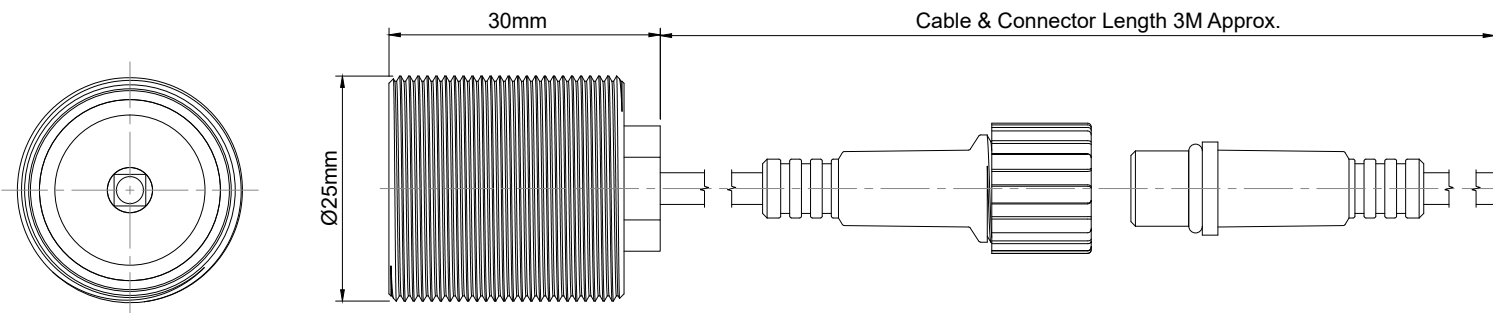

03-LEM002-30K or 40K

Enkin IP68 LED Dimmable Module (Without Connector)

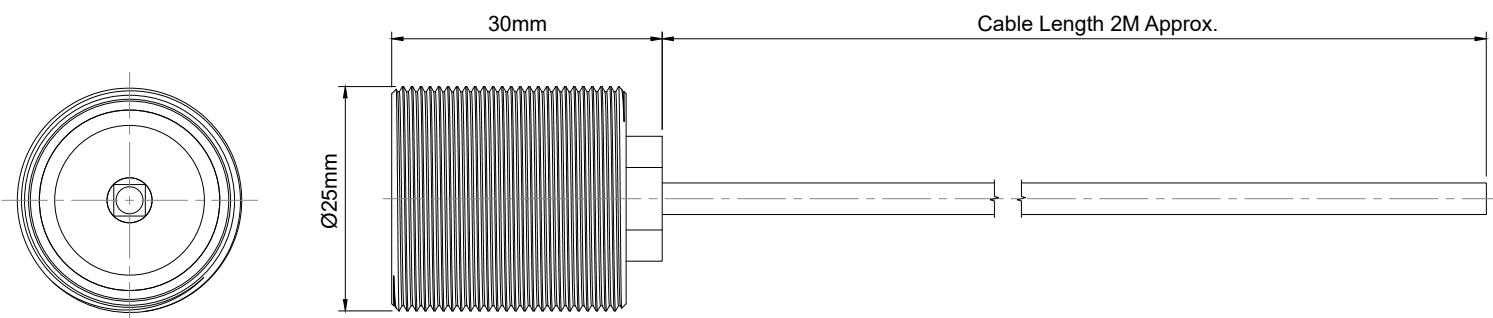

WARNING

These LED products **MUST** be used in conjunction with a 24V DC SELV Driver
DO NOT CONNECT DIRECTLY TO THE 240V MAINS SUPPLY!

	03-LEM001-30K	03-LEM001-40K	03-LEM002-30K	03-LEM002-40K
Operating Voltage	24V DC	24V DC	24V DC	24V DC
Wattage	3W	3W	3W	3W
Lumens	187lm	220lm	187lm	220lm
CRI	>95	>95	>95	>95
Colour Temperature	3000k (Warm White)	4000k (Natural White)	3000k (Warm White)	4000k (Natural White)
Dimmable	Yes	Yes	Yes	Yes
Connector	Yes	Yes	No	No
Dimensions	30mm x Ø25mm	30mm x Ø25mm	30mm x Ø25mm	30mm x Ø25mm
Cable Length	3m Approx. Inc. Connector	3m Approx. Inc. Connector	2m Approx.	2m Approx.
Cable Diameter	Ø3.5mm	Ø3.5mm	Ø3.5mm	Ø3.5mm
Cable Colour	Black	Black	Black	Black
Protection Class	3	3	3	3
IP Rating	IP68	IP68	IP68	IP68
Trademarks	Enkin is a trading name of Trade Ivy. Registered in England Number: 10809945. Copyright © 2021			





WARNING - PLEASE READ



THIS PRODUCT MUST BE USED IN CONJUNCTION WITH AN SELV DRIVER.

IMPORTANT NOTE: Do not install in locations near unsupervised children, as these LEDs can get hot. Only use with a recommended solid metal enclosure, as this will dissipate any heat produced and extend the life of this LED.

RISK OF ELECTRIC SHOCK

- Hazardous voltage and electrical current may be present at the wire leads of this product even when the device is switched off.
- Lock out and tag the input circuit before accessing the wiring connections.
- This device must be installed by a qualified and experienced electrician in accordance with applicable current electrical regulation.
- To comply with all safety standards, the product must be used only for the purpose described in this instruction and must be installed in accordance with the wiring rules and regulation in the location where it is installed.
- There are no user serviceable parts inside the product.
Failure to follow these instructions can result in death or serious injury.

EQUIPMENT DAMAGE HAZARD

Pay attention to the specifications and wiring diagrams related to the installation. Do not use this product for any other purpose than specified in this instruction.

Thank you for purchasing this Enkin product. We are confident that you will have many years of trouble free use. However, if for some reason your product develops a fault within the warranty period, please contact the retailer where this item was purchased. Our warranty excludes:

- Misuse / Abuse
- User Damage / Neglect
- Wear and Tear
- Poor maintenance or failure to follow instructions.
- Warranty is limited to purchase price of product and does not cover damages or loss in excess of this amount.
Proof of purchase is required.

ENVIRONMENTAL PROTECTION

Waste electrical products should not be disposed of with household waste. Please recycle where facilities exist. Check with your local authority or retailer for recycling advice.

LEGAL DISCLAIMER

The installation of electrical products is inherently dangerous and can lead to serious injury or death. The products we sell **MUST** be installed by a qualified and experienced electrician in accordance with applicable current electrical regulation. Any advice, guidance or other information provided by Enkin on their website or within any of our publications cannot completely anticipate your situation and common sense must prevail. Products need to be checked prior to installation and regularly for damage and wear and tear. Products should be returned and not used if in any doubt of their integrity.

Electrical rated loads and limits of a given product should **NEVER** be exceeded at any time. The electricity supply should always be isolated at its source (Distribution Board) before attempting any installation or maintenance.

No advice or information, whether oral or written, obtained by you from us or through the service, our employees, consultants and/or retailers shall create any warranty not expressly made herein.

You agree to assume all and any risk resulting from the utilisation of information provided by Enkin. You also expressly agree not to hold us responsible for any damage, personal injury, death or loss resulting from your use of our information, service or regulatory compliant products.