

22-LTS508

## 8 Gang Dimming Toggle Switch - Traditional Plate

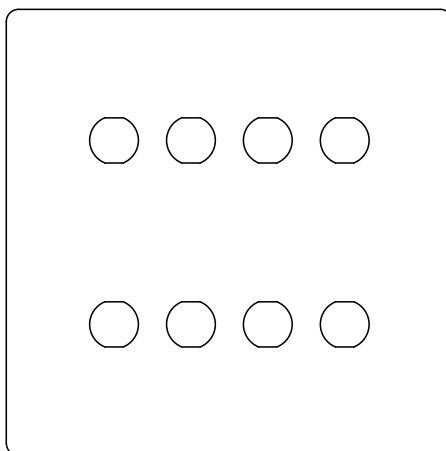

20-GRD139

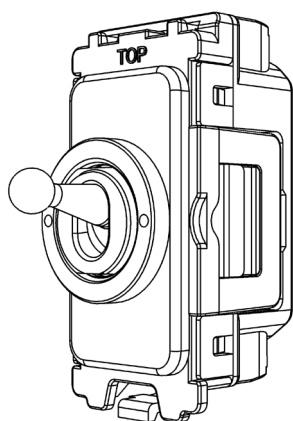

SGP316

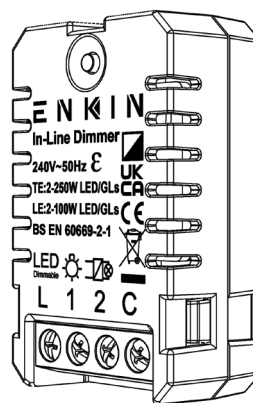

IDM250

### Contents

<b>20-GRD139</b>	8 Gang Circular Hole Grid Plate - Traditional
	<ul style="list-style-type: none"> <li>— 20-PLT139 8 Gang Circular Hole Traditional Grid Plate</li> <li>— 20-EDG009 Single Traditional Type Gasket</li> <li>— SGPYLK-34 Single Grid Frame (Yoke) X 2</li> </ul>
<b>SGP316</b>	20A 1 Way Retractive Switch - Grid Module X 8
<b>Enkin IDM250</b>	250W Universal In-Line LED dimmer X 8
<b>Trademarks</b>	The Soho Lighting Company is a registered trade mark number: UK00003313349, EU017906396, Date: 25 May 2018

POWERED BY  
**ENKIN**

# 20-GRD132-139

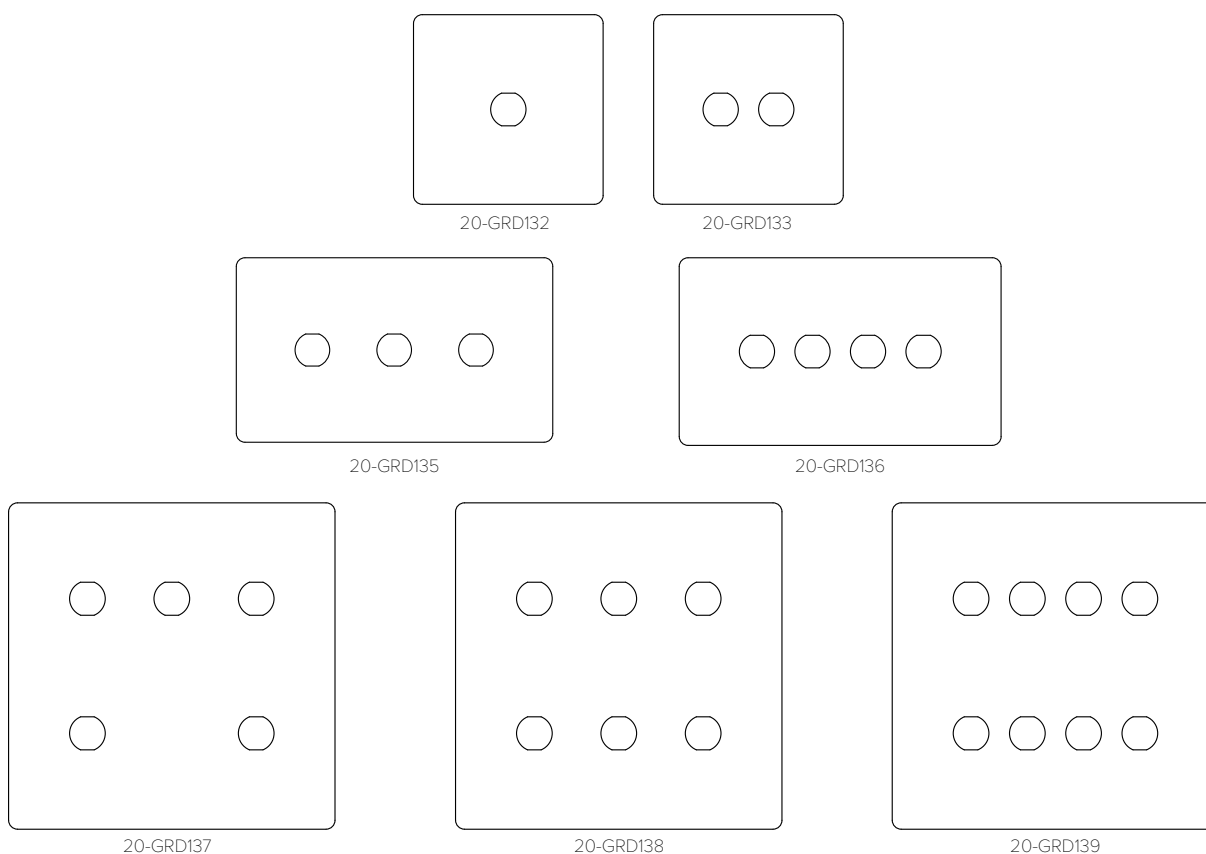

## TECHNICAL SPECIFICATION

Standard(s)	BS 5733 (Where Applicable)
Mounting Box Depth (Recommended)	47mm
Earth Terminal Capacity	3 x 2.5mm <sup>2</sup> , 2 x 4.0mm <sup>2</sup> , 1 x 6.0mm <sup>2</sup> (EARTH)
Fixing Centres	60.3mm (Single width) 120.6mm (Double Width)
Size - (1 Gang) 20-GRD132	86mm x 86mm x 4.5mm (Plate Thickness Inc. Gasket)
Size - (2 Gang) 20-GRD133	86mm x 86mm x 4.5mm (Plate Thickness Inc. Gasket)
Size - (3 Gang) 20-GRD135	86mm x 146mm x 4.5mm (Plate Thickness Inc. Gasket)
Size - (4 Gang) 20-GRD136	86mm x 146mm x 4.5mm (Plate Thickness Inc. Gasket)
Size - (5 Gang) 20-GRD137	146mm x 146mm x 4.5mm (Plate Thickness Inc. Gasket)
Size - (6 Gang) 20-GRD138	146mm x 146mm x 4.5mm (Plate Thickness Inc. Gasket)
Size - (8 Gang) 20-GRD139	146mm x 146mm x 4.5mm (Plate Thickness Inc. Gasket)
Product Class 1	Face plate must be earthed
Ambient Operating Temperature	-5° to +40°C
Recommended Location	Internal Use Only
Maximum Installation Altitude	2000m
IP Rating	IP2XD
Trademarks	The Soho Lighting Company is a registered trade mark number: UK00003313349, EU017906396, Date: 25 May 2018

## 20A 1 Way Retractive CM - Grid Toggle Switch Module

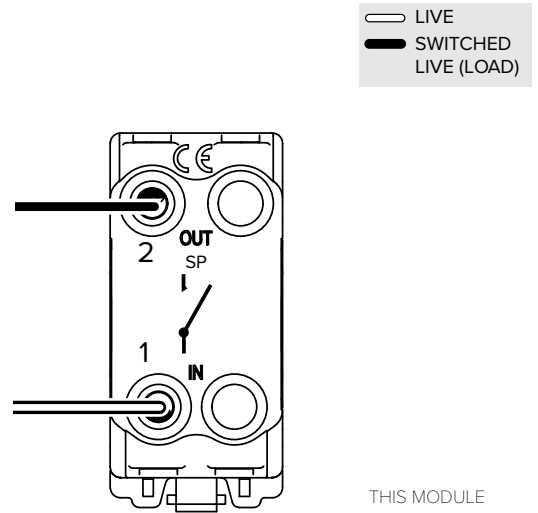
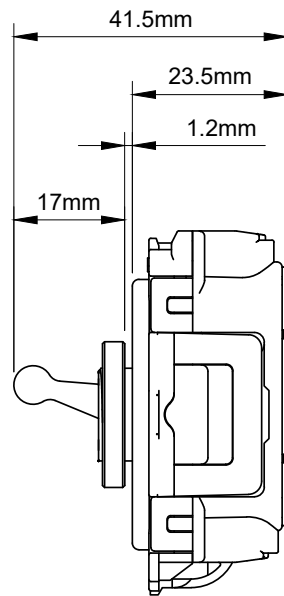
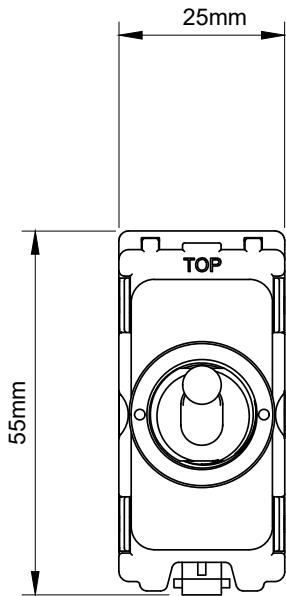

THIS MODULE MUST BE FITTED TO AN EARTHED FACE PLATE

### TECHNICAL SPECIFICATION

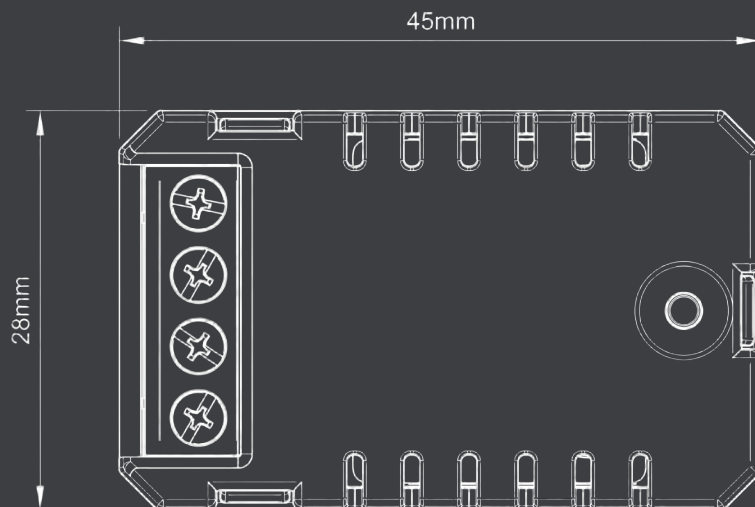
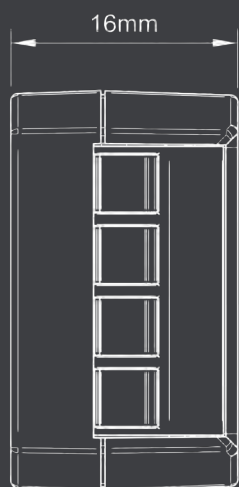

Standard(s)	BS EN 60669-1
Voltage Rating	20 Amp, 250V~ (20AX – no derating for inductive or fluorescent loads)
Contact Gap	Normal Gap
Mounting Box Depth (Min)	N/A
Terminal Capacity	4x 1.5mm <sup>2</sup> , 2x 2.5mm <sup>2</sup> & 1x 4.0mm <sup>2</sup>
Size	55mm x 25mm x 41.5mm
Product Class 1	Face plate must be earthed
Ambient Operating Temperature	-5° to +40°C
Recommended Location	Internal Use Only
Maximum Installation Altitude	2000m
IP Rating	IP2XD
Switched Poles	Single
Mains Frequency	50hz - 60hz
Contact Gap Minimum	3mm
Trademarks	The Soho Lighting Company is a registered trade mark number: UK00003313349, EU017906396, Date: 25 May 2018



<b>Markings &amp; Standard(s)</b>	CE, UKCA, BS EN 60669-2-1
<b>Operating Voltage</b>	220-240V AC
<b>Main Frequency</b>	50Hz
<b>Minimum Load</b>	2W LED (2W Incandescent / Halogen)
<b>Maximum Load</b>	250W LED (250W Incandescent / Halogen)
<b>Switch Type</b>	Multi-way (Retractive switch)
<b>Dimming Protocol</b>	Trailing edge & leading edge phase control
<b>Mounting Box Depth (Min)</b>	35mm
<b>Terminal Capacity</b>	1 x 4mm <sup>2</sup> / 1 x 2.5mm <sup>2</sup> / 3 x 1.5mm <sup>2</sup> / 4 x 1mm <sup>2</sup>
<b>Terminal Markings</b>	L (Load), 1, 2, C (Live)
<b>Neutral Required</b>	No
<b>Short Circuit Protection</b>	Yes
<b>Overload/Overcurrent Protection</b>	Yes
<b>Thermal Protection</b>	Yes - Thermal resettable fuse
<b>Soft Start</b>	Yes
<b>Power Failure</b>	Previous state recall
<b>Memory</b>	Non volatile
<b>Min/Max Level Setting</b>	Yes - Following a defined procedure
<b>Driving Mode</b>	Yes - TE & LE mode Change following a defined procedure
<b>Product Dimensions</b>	48mm x 28mm x 15.9mm
<b>Climate Range</b>	0°C to 40°C, Humidity 0% to 95% non-condensing
<b>Recommended Location</b>	Indoor use only
<b>Maximum Installation Altitude</b>	2000m
<b>IP Rating</b>	IP2XD
<b>Trademarks</b>	Enkin is a trading name of Trade Ivy. Registered in England Number: 10809945. Copyright © 2021



<b>Operating Voltage</b>	240V ac
<b>Nominal Operating Frequency</b>	50 Hz
<b>Dimming Technique</b>	Trailing & leading edge phase control
<b>Compliance</b>	BS EN 60669-2-1

Load Symbol	Compatible Loads	Max Load	Min Load
	Dimmable LED lighting	250W TE 100W LE	2W
	240V Incandescent & Halogen lamps	250W TE 100W LE	2W
	Low voltage lighting with electronic transformers	250W TE 100W LE	2W

Multi-Gang Switch De-Rating Chart				
1 Gang	2 Gang	3 Gang	4 Gang	5 Gang
250W	212W	175W	137W	100W

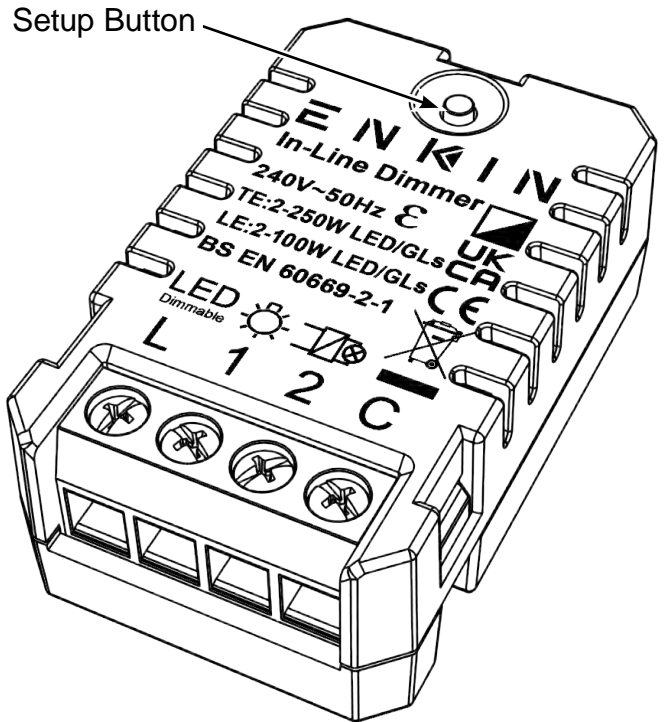

### WIRING EXAMPLES

#### WIRING DIAGRAM

##### Single Retractive Switch

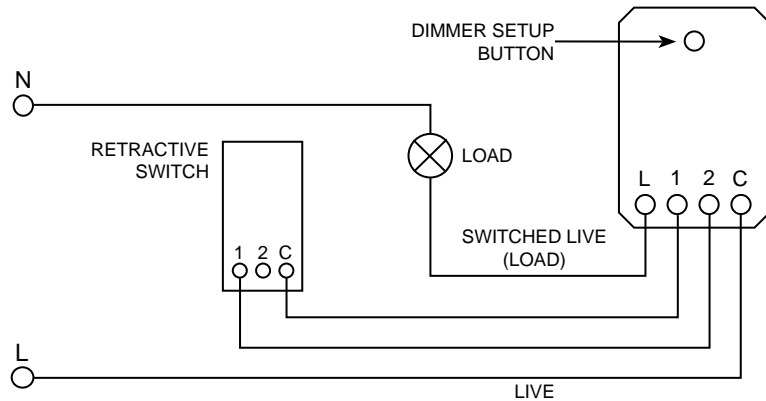

#### WIRING DIAGRAM

##### Multiple Retractive Switches

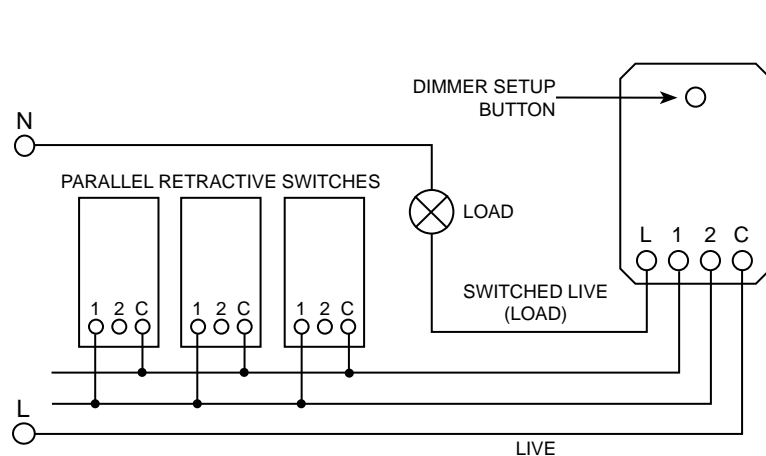

### OPERATING INSTRUCTIONS

On/Off and dimming is achieved with a connected retractive switch, or multiple (parallel) retractive switches, please refer to example circuit diagrams on the other side of this document for details.

A fast click of the retractive switch will turn the lamp (or Load) on and off, holding the switch will alternately dim the lamp up or down, release the switch when desired lamp brightness has been achieved.

The minimum/maximum level and dimming mode can be manually adjusted by following the procedures below.

#### SETTING THE MINIMUM LEVEL

1. Whilst on, adjust dimmer to your desired minimum brightness.
2. Push the setup button 3 times within 2 seconds.
3. The LEDs will step up and down in brightness once to confirm the setting has been saved.

#### SETTING THE MAXIMUM LEVEL

1. Whilst on, adjust dimmer to your desired maximum brightness.
2. Push the setup button 5 times within 3 seconds.
3. The LEDs will step up and down in brightness once to confirm the setting has been saved.

#### FACTORY RESET FOR MIN/MAX BRIGHTNESS

Please note this factory reset will reset all the min and max brightness settings.

1. Whilst on, push the rear setup button 7 times within 5 seconds.
2. The LEDs will step up and down in brightness three times to confirm that the min/max setting has been cleared.

#### CHANGING THE DIMMING MODE

The default mode of the dimmer is Trailing Edge, but it can be put into Leading Edge if required. Please ensure that you know the correct mode for your lamp.

1. Whilst on, push the setup button 9 times within 5 seconds.
2. The LEDs will step up and down in brightness twice to confirm the setting has been changed to Leading Edge mode.

#### NOTE:

To switch back to Trailing Edge mode, just repeat the process again, the LEDs will step up and down once to show the dimmer is back in Trailing Edge mode.



IDM250 250W Universal In-Line LED dimmer

**E N K I N**