

22-LTS351

1 Gang 150W Smart Toggle Switch - Traditional

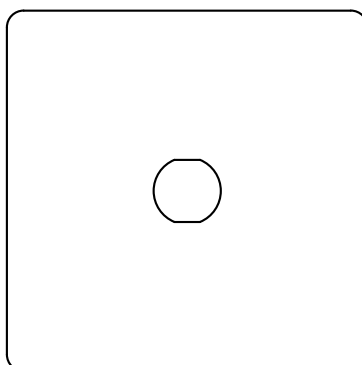

22-GRD132

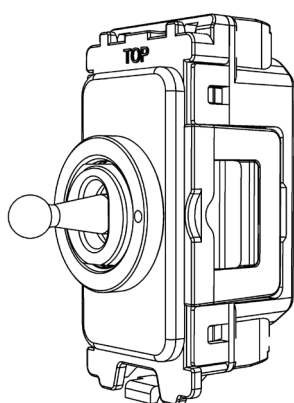

SGP315

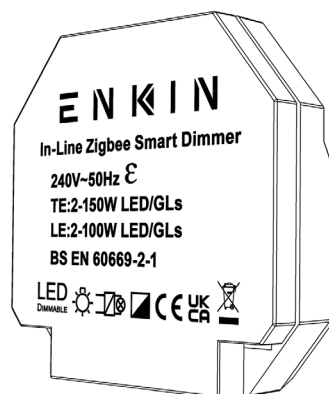

ZDM150

Contents

22-GRD132	1 Gang Circular Hole Grid Plate - Traditional
	<ul style="list-style-type: none"> — 20-PLT132 1 Gang Circular Hole Traditional Grid Plate — 20-EDG007 Single Traditional Type Gasket — SGPYLK-12 Single Grid Frame (Yoke)
SGP315	20A 2 Way & Off Retractive CM-Grid Toggle Switch - Grid Module
Enkin ZDM150	150W LED Zigbee Module
Trademarks	The Soho Lighting Company is a registered trade mark number: UK00003313349, EU017906396, Date: 25 May 2018

POWERED BY
ENKIN

20-GRD132-139

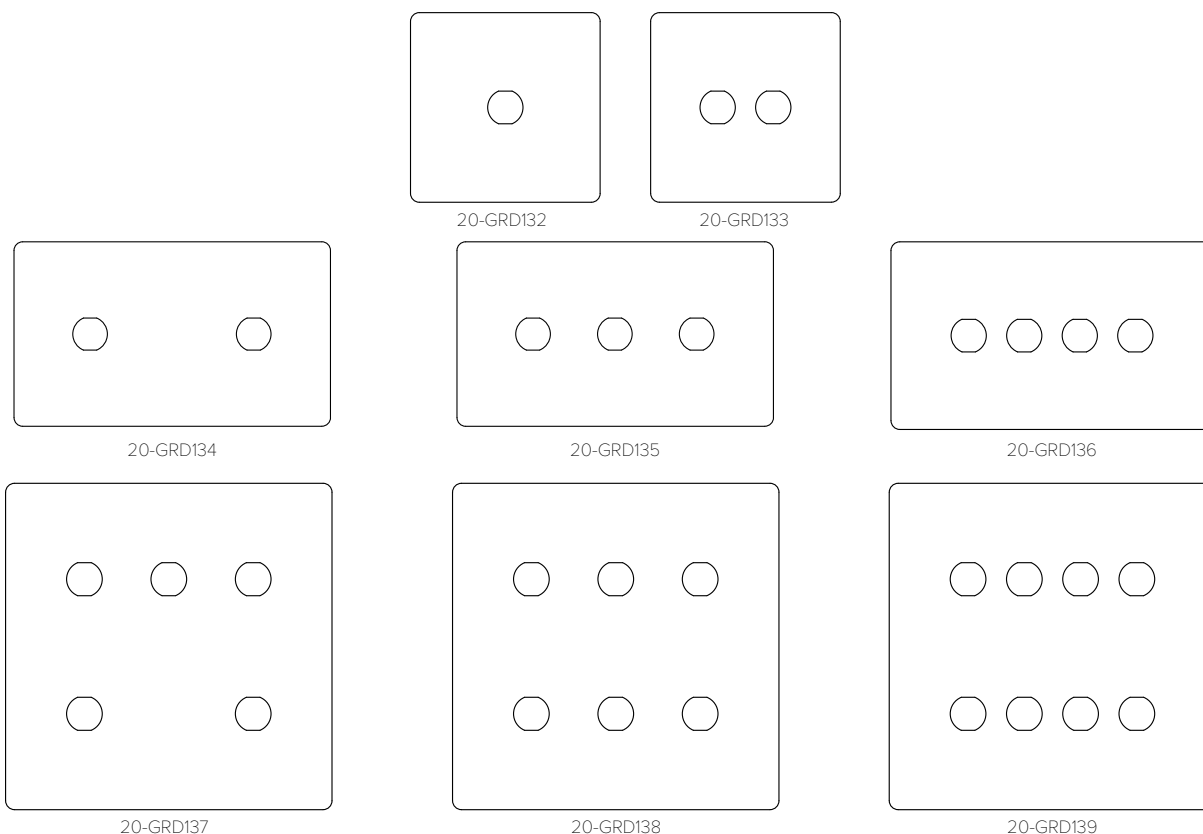

TECHNICAL SPECIFICATION

Standard(s)	BS 5733 (Where Applicable)
Mounting Box Depth (Recommended)	47mm
Earth Terminal Capacity	3 x 2.5mm ² , 2 x 4.0mm ² , 1 x 6.0mm ² (EARTH)
Fixing Centres	60.3mm (Single width) 120.6mm (Double Width)
Size - (1 Gang) 20-GRD132	86mm x 86mm x 4.5mm (Plate Thickness Inc. Gasket)
Size - (2 Gang) 20-GRD133	86mm x 86mm x 4.5mm (Plate Thickness Inc. Gasket)
Size - (2 Gang) 20-GRD134	86mm x 146mm x 4.5mm (Plate Thickness Inc. Gasket)
Size - (3 Gang) 20-GRD135	86mm x 146mm x 4.5mm (Plate Thickness Inc. Gasket)
Size - (4 Gang) 20-GRD136	86mm x 146mm x 4.5mm (Plate Thickness Inc. Gasket)
Size - (5 Gang) 20-GRD137	146mm x 146mm x 4.5mm (Plate Thickness Inc. Gasket)
Size - (6 Gang) 20-GRD138	146mm x 146mm x 4.5mm (Plate Thickness Inc. Gasket)
Size - (8 Gang) 20-GRD139	146mm x 146mm x 4.5mm (Plate Thickness Inc. Gasket)
Product Class 1	Face plate must be earthed
Ambient Operating Temperature	-5° to +40°C
Recommended Location	Internal Use Only
Maximum Installation Altitude	2000m
IP Rating	IP2XD
Trademarks	The Soho Lighting Company is a registered trade mark number: UK00003313349, EU017906396, Date: 25 May 2018

20A 2 Way & Off Retractive CM - Grid Toggle Switch Module

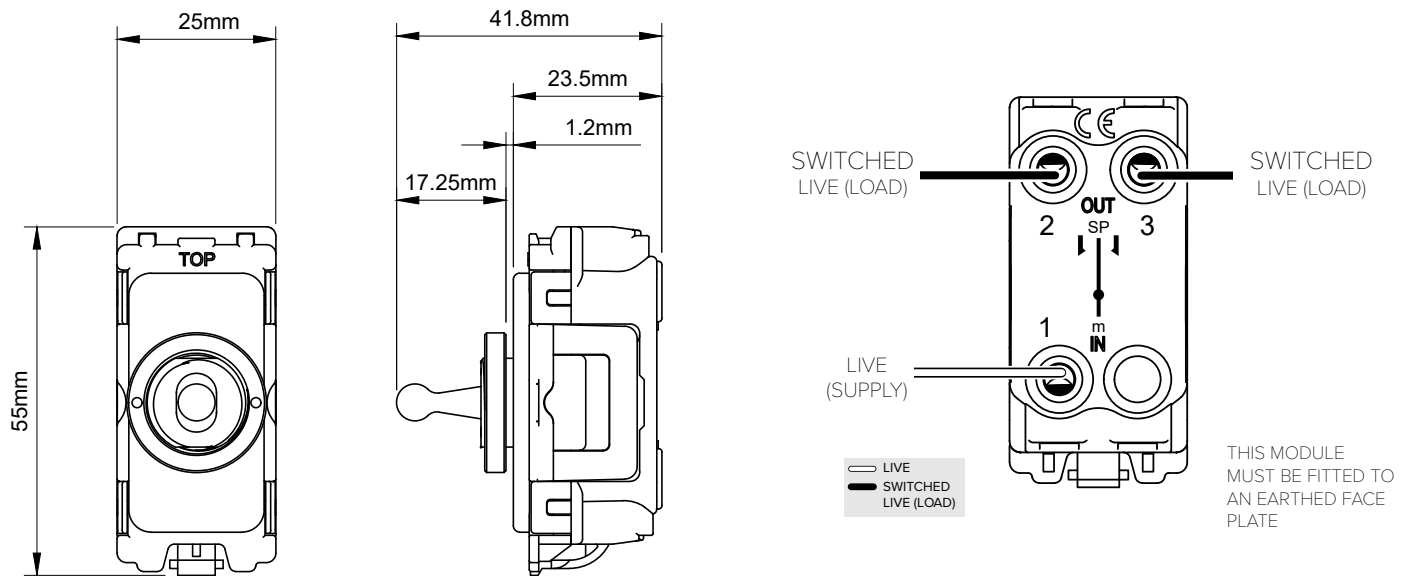

TECHNICAL SPECIFICATION

Standard(s)	BS EN 60669-1
Voltage Rating	20 Amp, 250V~ (20AX – no derating for inductive or fluorescent loads)
Contact Gap	Mini-gap
Mounting Box Depth (Min)	35mm
Terminal Capacity	4x 1.5mm ² , 2x 2.5mm ² & 1x 4.0mm ²
Size	55mm x 25mm x 41.8mm
Product Class 1	Face plate must be earthed
Ambient Operating Temperature	-5° to +40°C
Recommended Location	Internal Use Only
Maximum Installation Altitude	2000m
IP Rating	IP2XD
Switched Poles	Single
Mains Frequency	50hz - 60hz
Contact Gap Minimum	3mm
Trademarks	The Soho Lighting Company is a registered trade mark number: UK00003313349, EU017906396, Date: 25 May 2018

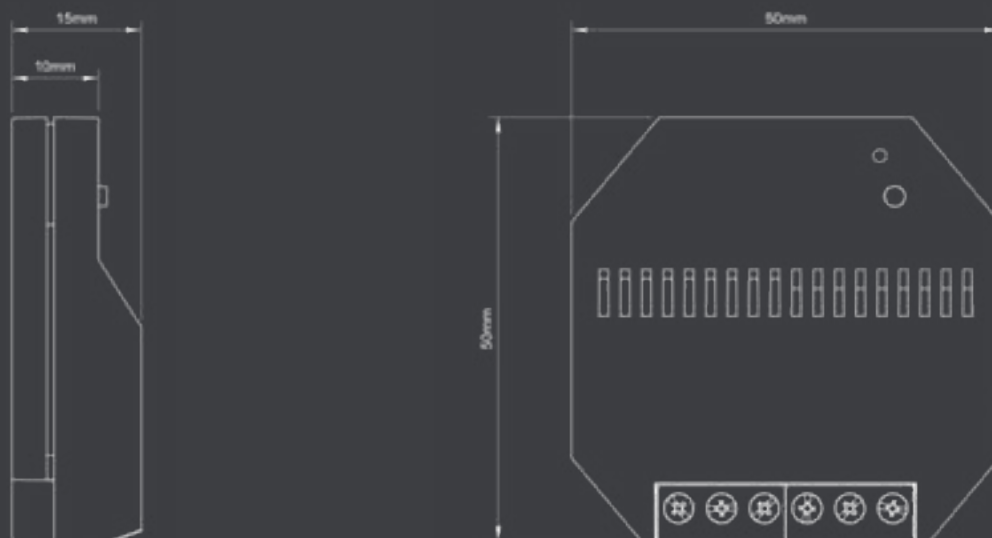

Markings & Standard(s)	CE, UKCA, BS EN 60669-2-1
Zigbee Protocol	3.0
Operating Voltage	220-240V AC
Main Frequency	50Hz
Minimum Load	2W LED (2W Incandescent / Halogen)
Maximum Load	150W LED (150W Incandescent / Halogen)
Switch Type	Multi way (retractive switch), (2way up/down retractive switch)
Dimming Protocol	Trailing edge & leading edge phase control
Mounting Box Depth (Min)	35mm
Terminal Capacity	1 x 4mm ² / 1 x 2.5mm ² / 3 x 1.5mm ² / 4 x 1mm ²
Terminal Markings	2 x 'C' (live), '1' x L (load), '1' x for one way push retractive switch, '2' x for 2 way retractive switch
Neutral Required	No
Short Circuit Protection	Yes
Overload/Overcurrent Protection	Yes
Thermal Protection	Yes - Thermal resettable fuse
Soft Start	Yes
Power Failure	Previous state recall
Memory	Yes, non volatile
Min/Max Level Setting	Yes - Following a defined procedure
Driving Mode	Yes - TE & LE mode change following a defined procedure
Product Dimensions	50mm x 49.5mm x 15.1mm
Climate Range	0°C to 40°C, Humidity 0% to 95% non-condensing
Recommended Location	Indoor use only
Maximum Installation Altitude	2000m
IP Rating	IP2XD
Trademarks	Enkin is a trading name of Trade Ivy. Registered in England Number: 10809945. Copyright © 2021



Operating Voltage	240V ac
Nominal Operating Freq.	50 Hz
Dimming Technique	Trailing & Leading Edge Phase Control
Compliance	BS EN 60669-2-1

Load Symbol	Compatible Loads	Max Load	Min Load
	Dimmable LED lighting	150W TE 100W LE	2W
	240V Incandescent & Halogen lamps	150W TE 100W LE	2W
	Low voltage lighting with electronic transformers	150W TE 100W LE	2W

Multi-Gang Switch De-Rating Chart				
1 Gang	2 Gang	3 Gang	4 Gang	5 Gang
150W	127W	105W	82W	60W

IMPORTANT NOTE:

Some driverless products can still operate with a small amount of residual current present, such as LED strip lighting etc, it may be necessary to fit a bypass device to allow this product to dim completely to off.

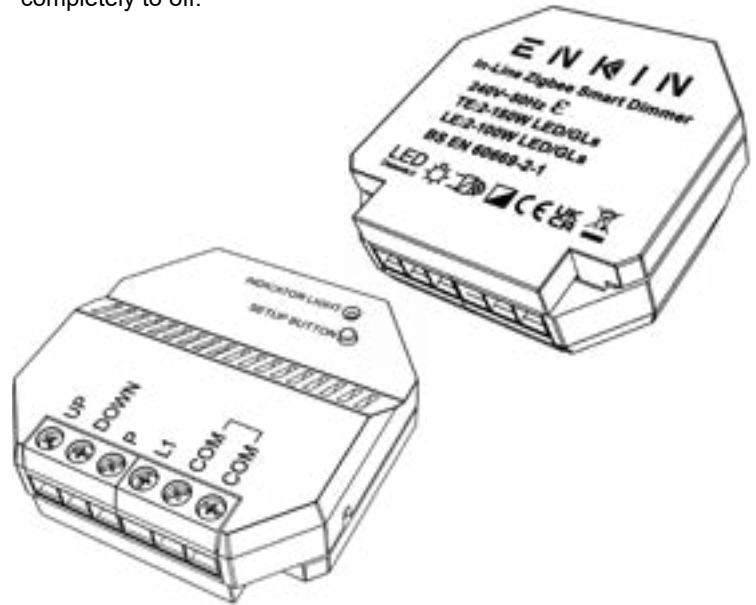

WIRING EXAMPLES

ONE-WAY PUSH RETRACTIVE SWITCH WIRING OPTION

NOTE:
FOR MULTIPLE SWITCH
LOCATIONS, PLEASE WIRE
SWITCHES IN PARALLEL

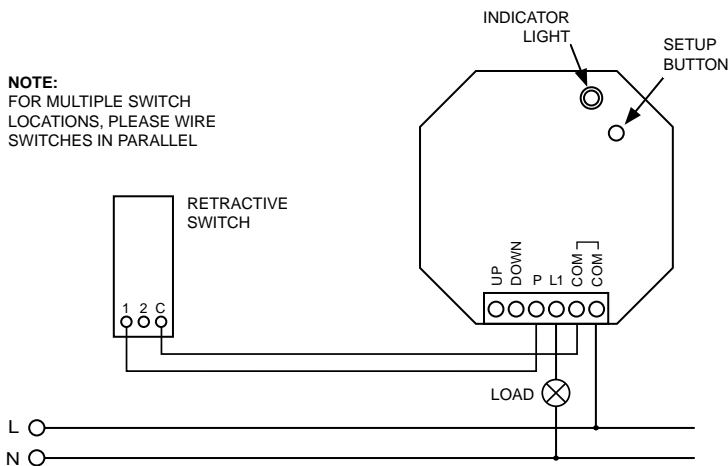

TWO-WAY & OFF PUSH RETRACTIVE SWITCH WIRING OPTION

NOTE:
FOR MULTIPLE SWITCH
LOCATIONS, PLEASE WIRE
SWITCHES IN PARALLEL

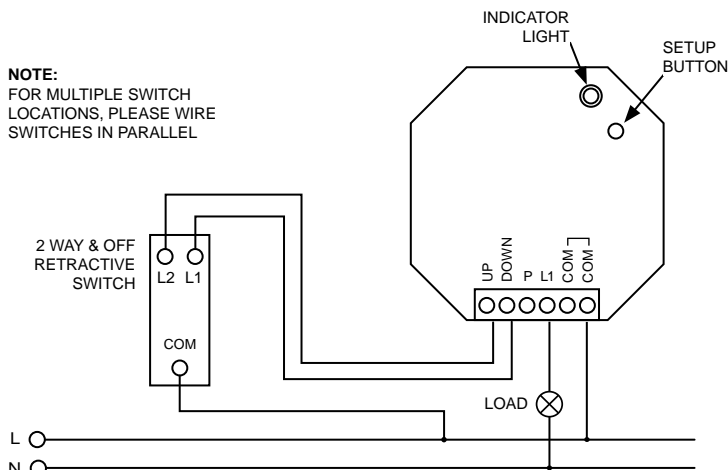

DIMMER SETUP

NOTE: Manual control of the On/Off function and dimming up and down can also be achieved with a connected Retractive Switch, or multiple (parallel) Retractive Switches. Please refer to example circuit diagrams to the right of this text for some connection examples of this option.

A fast click of the retractive switch will turn the lamp (or Load) on and off, holding the switch will alternately dim the lamp up or down, release the switch when desired lamp brightness has been achieved.

The minimum/maximum level and dimming mode can be manually adjusted by following the procedures below.

SETTING THE MINIMUM LEVEL

1. Whilst on, adjust dimmer to your desired minimum brightness.
2. Push the rear setup button 3 times within 2 seconds.
3. The LEDs will step up and down in brightness once to confirm the setting has been saved.

SETTING THE MAXIMUM LEVEL

1. Whilst on, adjust dimmer to your desired maximum brightness.
2. Push the rear setup button 5 times within 3 seconds.
3. The LEDs will step up and down in brightness once to confirm the setting has been saved.

FACTORY RESET FOR MIN/MAX BRIGHTNESS

1. Please note this factory reset will reset all the min and max brightness settings.
2. Whilst on, push the rear setup button 7 times within 5 seconds.
3. The LEDs will step up and down in brightness three times to confirm that the min/max setting has been cleared.

CHANGING THE DIMMING MODE

The default mode of the dimmer is Trailing Edge, but it can be put into Leading Edge if required. Please ensure that you know the correct mode for your lamp.

1. Whilst on, push the rear setup button 9 times within 5 seconds.
2. The LEDs will step up and down in brightness twice to confirm the setting has been changed to Leading Edge mode.

NOTE:

To switch back to Trailing Edge mode, just repeat the process again, the LEDs will step up and down once to show the dimmer is back in Trailing Edge mode.