

22-LTS262

2 Gang 1-10V DC Dimmer - Traditional Plate

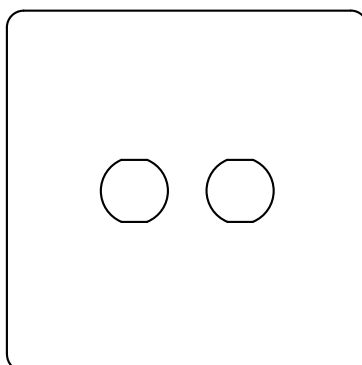

20-GRD133

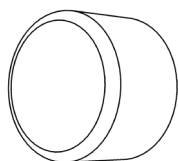

SGP146

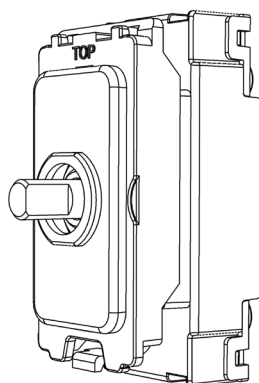

Enkin PDM010 & SOHO Grid Adapter

Contents

20-GRD133	2 Gang Circular Hole Grid Plate - Traditional
	<ul style="list-style-type: none"> — 20-PLT133 2 Gang Circular Hole Traditional Grid Plate — 20-EDG007 Single Traditional Type Gasket — SGPYLK-12 Single Grid Frame (Yoke)
SGP146	CM-Grid Dimmer Knob X 2
Enkin PDM010	1-10V DC Dimmer with Soho CM Grid Adapter X 2
Trademarks	The Soho Lighting Company is a registered trade mark number: UK00003313349, EU017906396, Date: 25 May 2018

POWERED BY
ENKIN

20-GRD132-139

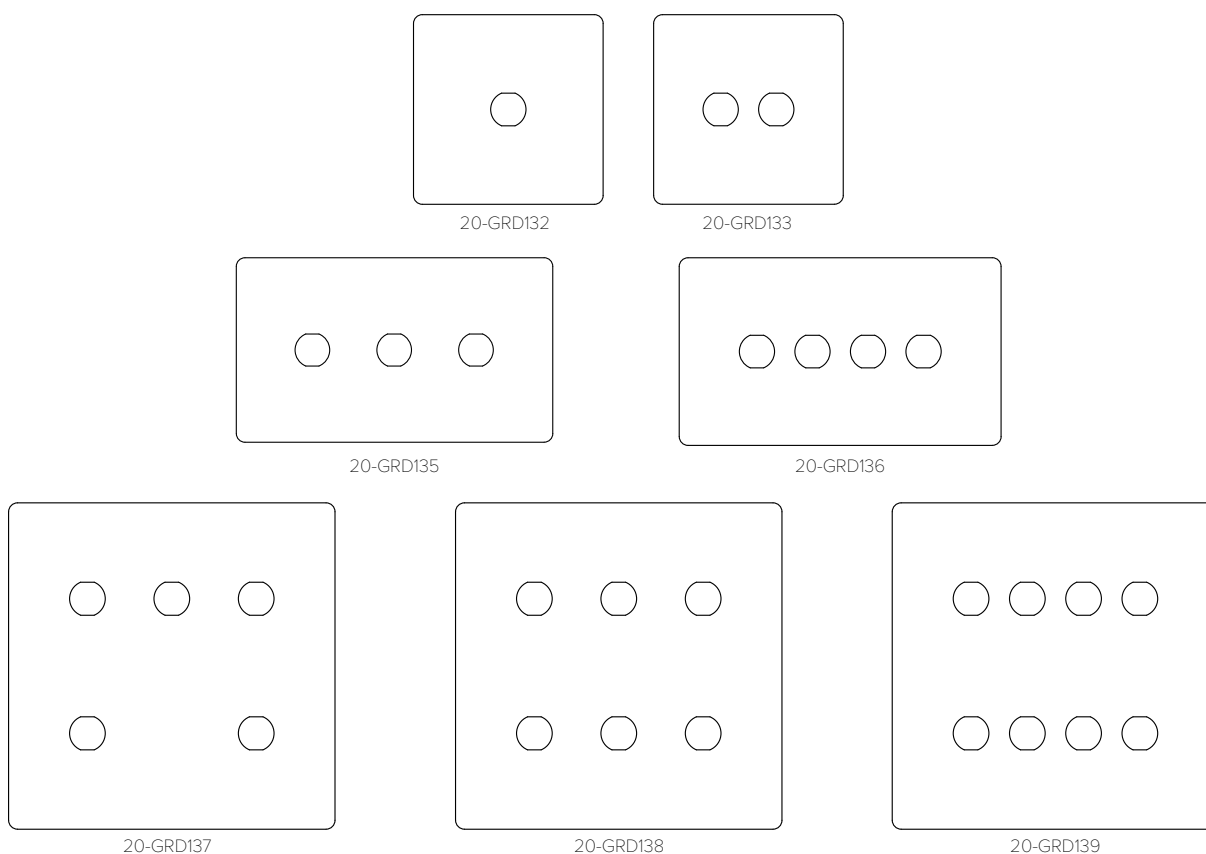

TECHNICAL SPECIFICATION

Standard(s)	BS 5733 (Where Applicable)
Mounting Box Depth (Recommended)	47mm
Earth Terminal Capacity	3 x 2.5mm ² , 2 x 4.0mm ² , 1 x 6.0mm ² (EARTH)
Fixing Centres	60.3mm (Single width) 120.6mm (Double Width)
Size - (1 Gang) 20-GRD132	86mm x 86mm x 4.5mm (Plate Thickness Inc. Gasket)
Size - (2 Gang) 20-GRD133	86mm x 86mm x 4.5mm (Plate Thickness Inc. Gasket)
Size - (3 Gang) 20-GRD135	86mm x 146mm x 4.5mm (Plate Thickness Inc. Gasket)
Size - (4 Gang) 20-GRD136	86mm x 146mm x 4.5mm (Plate Thickness Inc. Gasket)
Size - (5 Gang) 20-GRD137	146mm x 146mm x 4.5mm (Plate Thickness Inc. Gasket)
Size - (6 Gang) 20-GRD138	146mm x 146mm x 4.5mm (Plate Thickness Inc. Gasket)
Size - (8 Gang) 20-GRD139	146mm x 146mm x 4.5mm (Plate Thickness Inc. Gasket)
Product Class 1	Face plate must be earthed
Ambient Operating Temperature	-5° to +40°C
Recommended Location	Internal Use Only
Maximum Installation Altitude	2000m
IP Rating	IP2XD
Trademarks	The Soho Lighting Company is a registered trade mark number: UK00003313349, EU017906396, Date: 25 May 2018

SS-EN-00-PDM010

Enkin DC 1-10V Dimmer

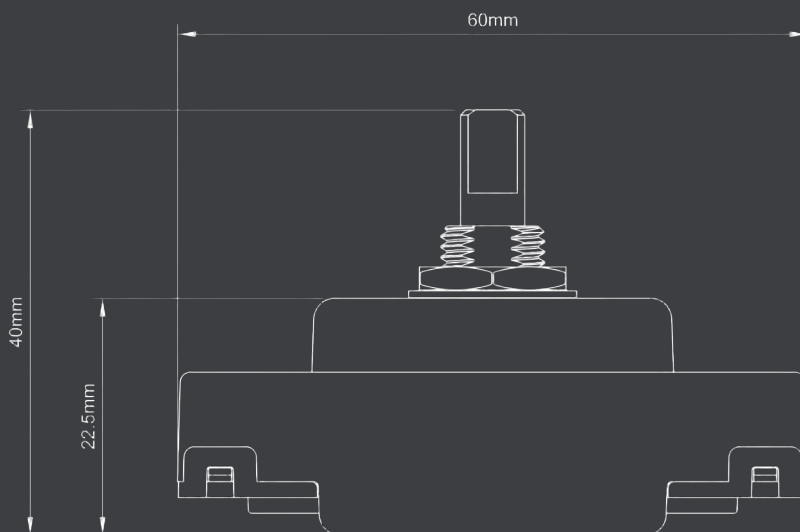
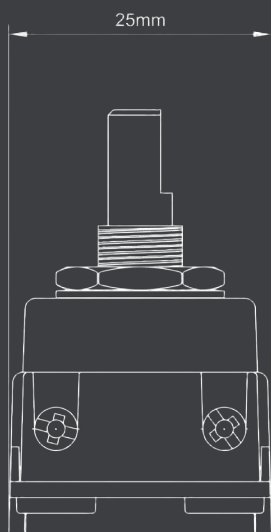

Markings & Standard(s)	CE, UKCA, BS EN 60669-2-1
Operating Voltage	220-240V AC
Main Frequency	50Hz
Minimum Load	N/A
Maximum Load	1000W
Switch Type	N/A
Dimming Protocol	DC 1-10V
Mounting Box Depth (Min)	35mm
Terminal Capacity	1 x 4mm ² / 1 x 2.5mm ² / 3 x 1.5mm ² / 4 x 1mm ²
Terminal Markings	Li, L0, D+, D-
Neutral Required	No
Short Circuit Protection	N/A
Overload/Overcurrent Protection	N/A
Thermal Protection	N/A
Soft Start	N/A
Power Failure	N/A
Memory	N/A
Min/Max Level Setting	N/A
Driving Mode	N/A
Product Dimensions	59.95mm x 25mm x 22.5mm
Climate Range	0°C to 40°C, Humidity 0% to 95% non-condensing
Recommended Location	Indoor Use Only
Maximum Installation Altitude	2000m
IP Rating	IP2XD
Trademarks	Enkin is a trading name of Trade Ivy. Registered in England Number: 10809945. Copyright © 2021



Operating Voltage (Ref. wiring diagram 2)	240V ac ~ 50 Hz
Max Load (Ref. wiring diagram 2)	1000W
Dimming Technique	DC 1-10V
Compliance	BS EN 60669-2-1

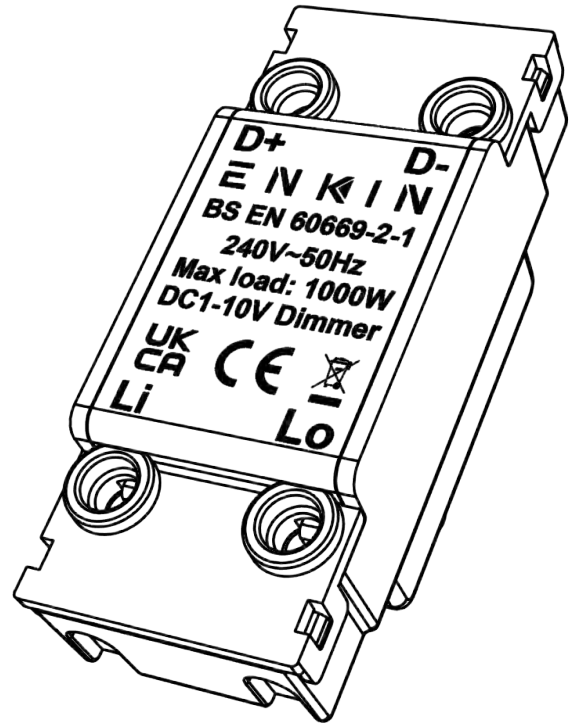

Load Symbol	Compatible Loads	Max Load
	1-10V, Dimmable LED	1000W

ON OFF & DIMMING FUNCTION

Dimmer switch is activated by pressing the dimmer shaft only, dimming function by rotating the dimmer shaft only.

WIRING EXAMPLES

EXAMPLE WIRING DIAGRAM 1.

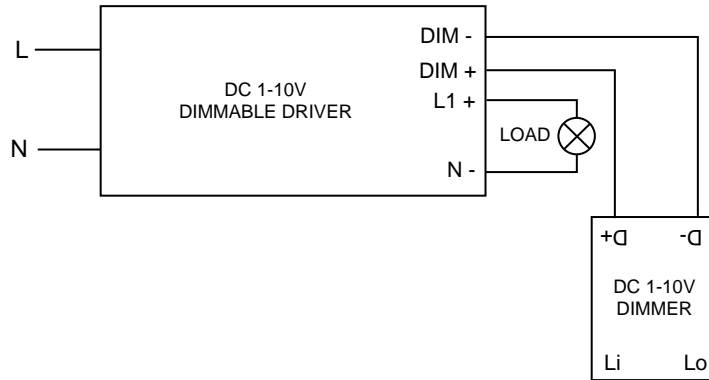

EXAMPLE WIRING DIAGRAM 2.

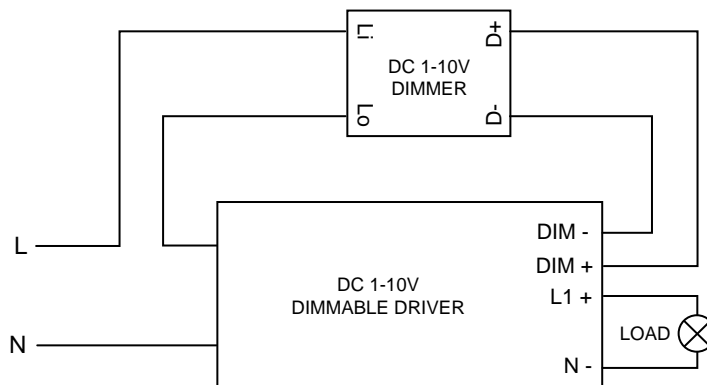

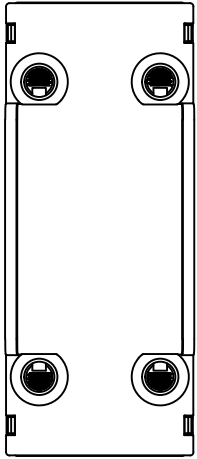
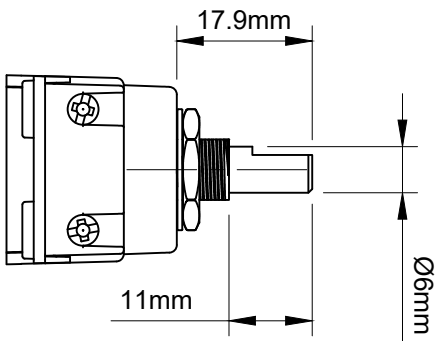
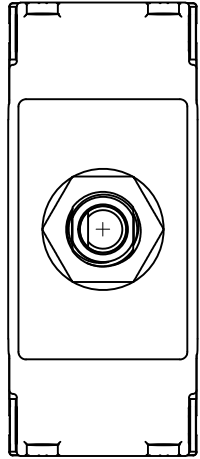
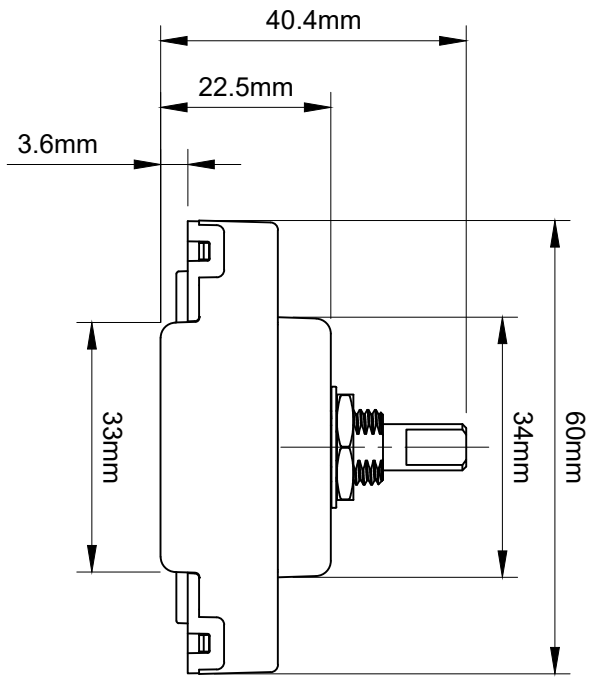
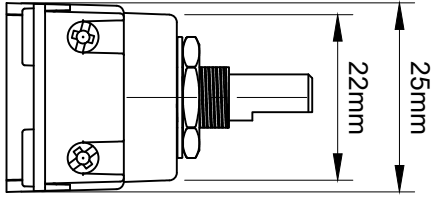
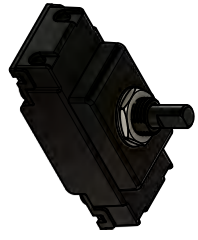

PDM010 Enkin DC 1-10V Dimmer

ENKIN