

20-PLT101

1 Gang Rectangular Grid Plate - Traditional Plate

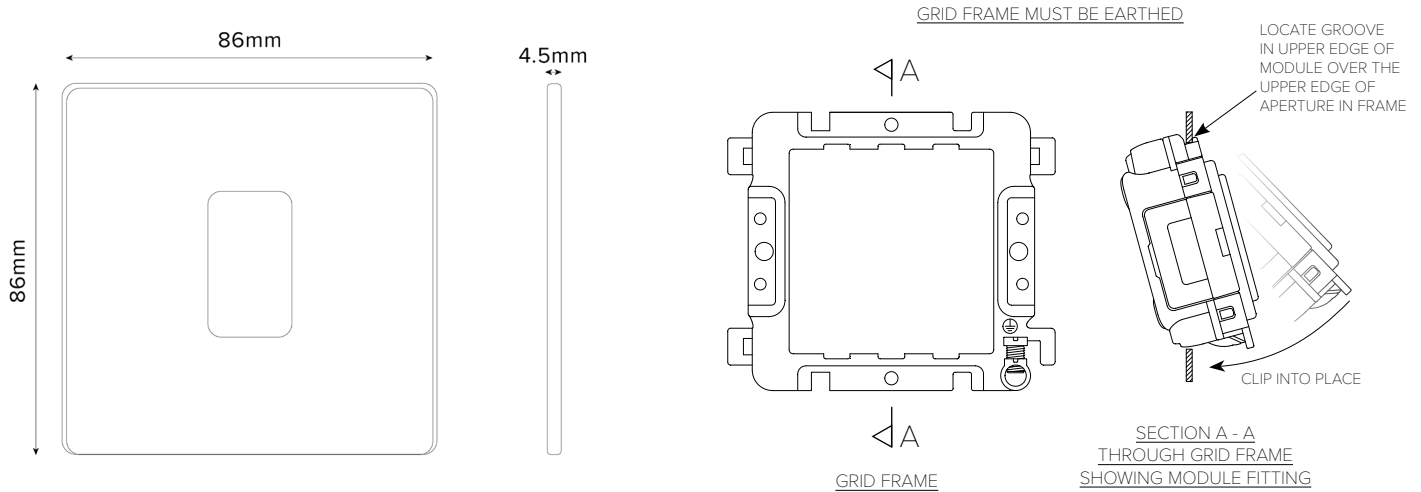

INSTRUCTIONS

1. Snap grid frame onto gasket, fit the earth lead and tighten the grid frame using the screws.
For installations with more than one grid frame, it is important that all of the grid frames are effectively connected to earth via their own respective earth terminals.
2. Pull cabling through frame and strip insulation accordingly, systematically terminate cables into each module.
3. Locate groove in upper edge of module over the upper edge of aperture in frame and clip into place.
4. For Screw-less Decorative range, snap the front plate onto the grid plate.

TECHNICAL SPECIFICATION

Standard(s)	BS 5733 (Where Applicable)
Mounting Box Depth (Min)	35mm
Earth Terminal Capacity	3 x 2.5mm ² , 2 x 4.0mm ² , 1 x 6.0mm ² (EARTH)
Fixing Centres	60.3mm
Size	86mm x 86mm x 4.5mm (Plate thickness)
Product Class 1	Face plate must be earthed
Ambient Operating Temperature	-5° to +40°C
Recommended Location	Internal Use Only
Maximum Installation Altitude	2000m
IP Rating	IP2XD
Trademarks	The Soho Lighting Company is a registered trade mark number: UK00003313349, EU017906396, Date: 25 May 2018