

2 Gang 6A SP Dimming Push Button Switch with Enkin IDM250 Traditional Plate

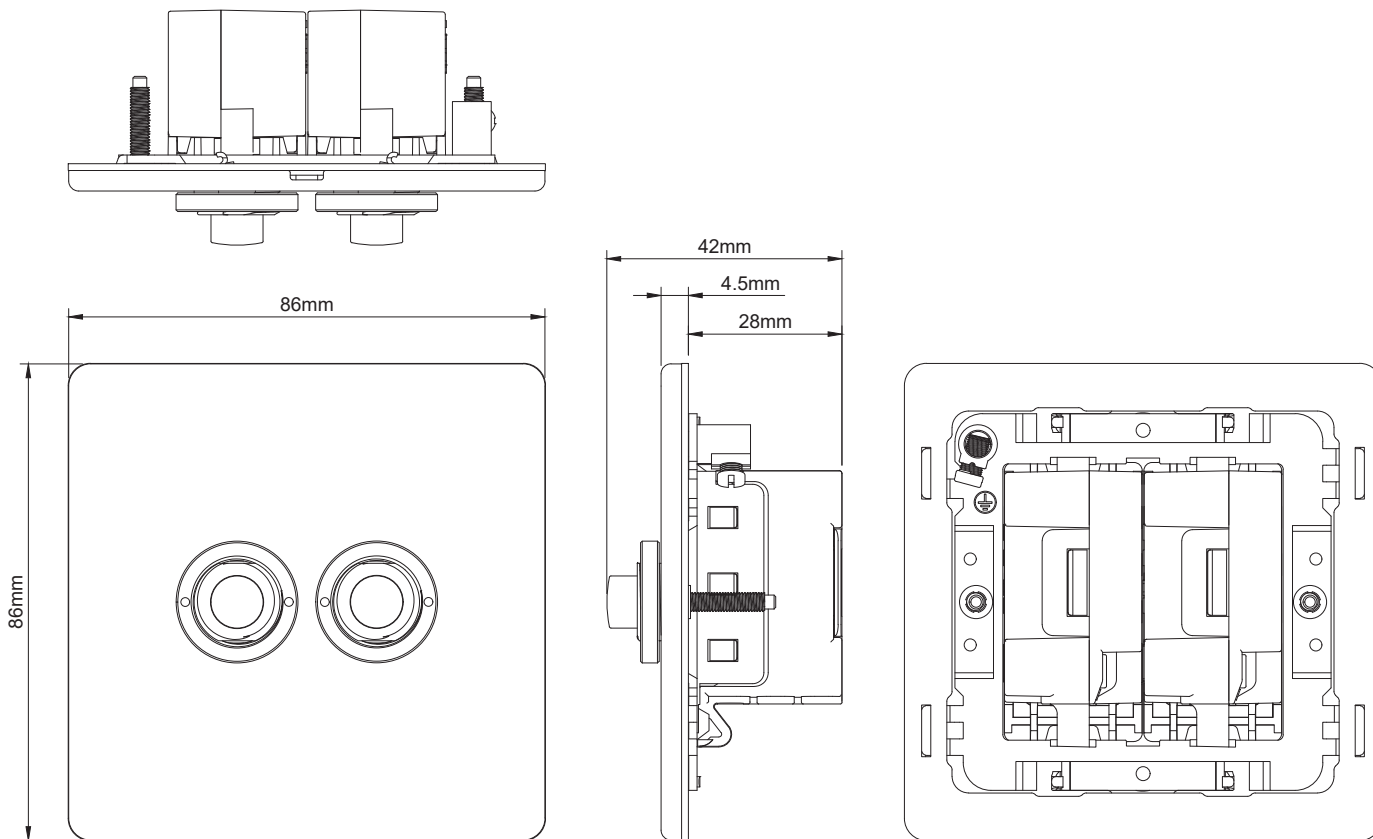

IMPORTANT NOTE: Recommended mounting box depth 47mm

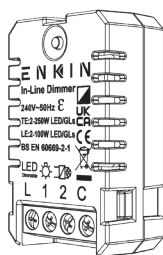

POWERED BY

ENKIN

Contents

20-GRD133	2 Gang CM Module Grid Switch Traditional Face Plate + Gasket + Frame
00-SGP211	6A SP 2 Way Retractive Push Button CM Grid Switch Module X2
IDM250	Enkin 250W Intelligent In-Line Dimmer Module X2
Trademarks	The Soho Lighting Company is a registered trade mark number: UK00003313349, EU017906396, Date: 25 May 2018

2 Gang CM Module Grid Switch Traditional Face Plate + Gasket + Frame

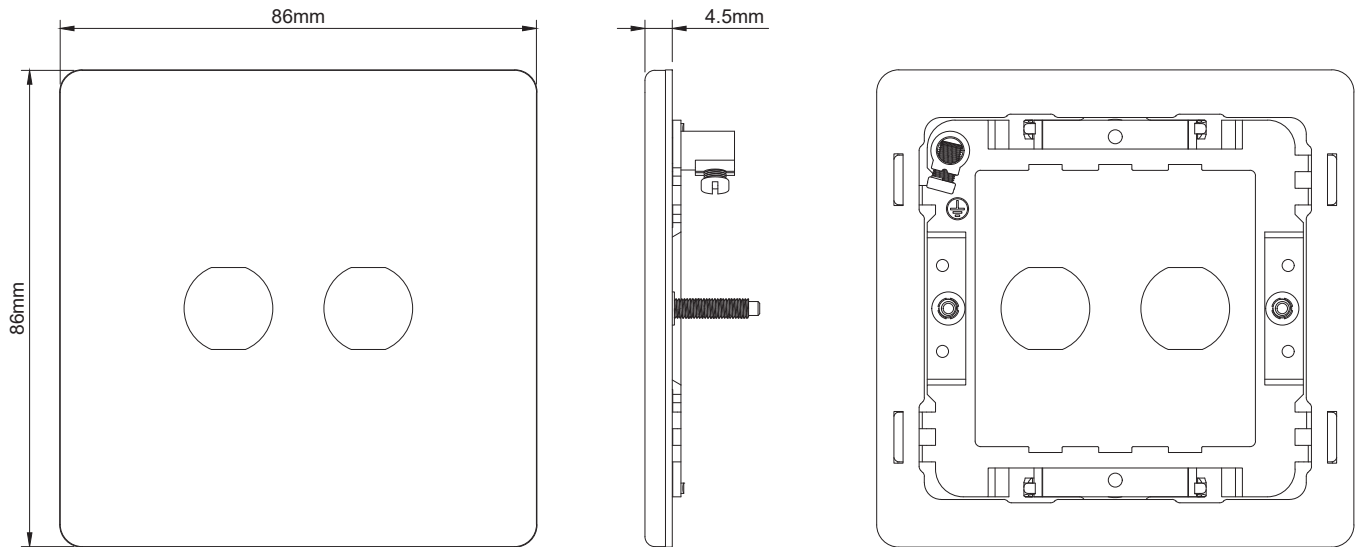

TECHNICAL SPECIFICATION

Standard(s)	BS 5733 (Where Applicable)
Mounting Box Depth (Min)	35mm
Earth Terminal Capacity	3 x 2.5mm ² , 2 x 4.0mm ² , 1 x 6.0mm ² (EARTH)
Fixing Centres	60.3mm
Size	86mm x 86mm x 4.5mm (Plate thickness)
Product Class 1	Product must be earthed
Ambient Operating Temperature	-5° to +40°C
Recommended Location	Internal Use Only
Maximum Installation Altitude	2000m
IP Rating	IP2XD
Trademarks	The Soho Lighting Company is a registered trade mark number: UK00003313349, EU017906396, Date: 25 May 2018

6A SP 2 Way Retractive Push Button CM Grid Switch Module

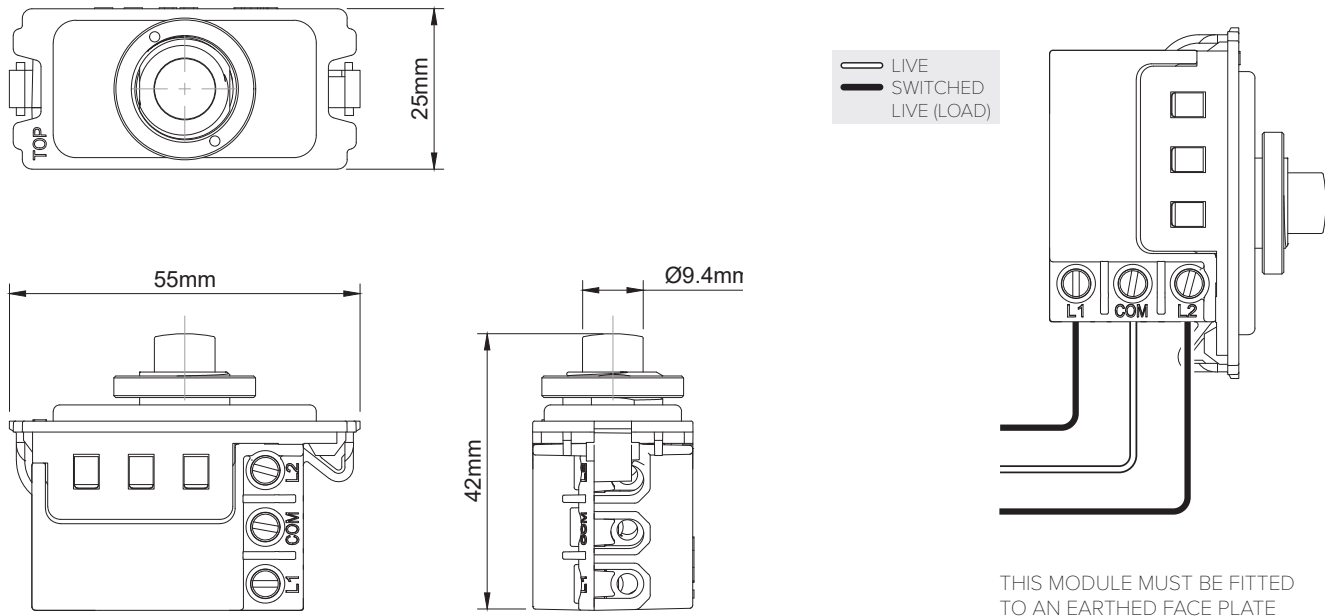

TECHNICAL SPECIFICATION

Standard(s)	BS EN 60669-1
Rating	6 Amp, 250V~
Switch Type	Single Pole
Contact Gap	Normal Gap
Terminal Capacity	3x 1.0mm ² , 2x 1.5mm ²
Size	25mm x 55mm x 42mm
Mounting Box Depth (Min)	35mm
Ambient Operating Temperature	-5° to +40°C
Recommended Location	Internal Use Only
Maximum Installation Altitude	2000m
IP Rating	IP2XD
Trademarks	The Soho Lighting Company is a registered trade mark number: UK00003313349, EU017906396, Date: 25 May 2018

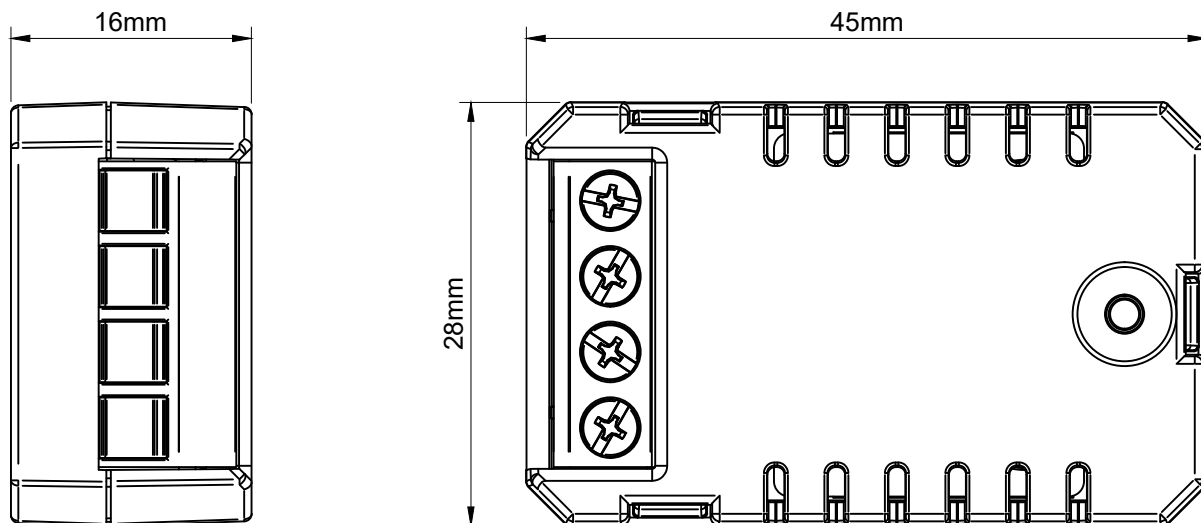

Markings & Standard(s)	CE, UKCA, BS EN 60669-2-1
Operating Voltage	220-240V AC
Main Frequency	50Hz
Minimum Load	2W LED (2W Incandescent / Halogen)
Maximum Load	250W LED (250W Incandescent / Halogen)
Switch Type	Multi-way (Retractive switch)
Dimming Protocol	Trailing edge & leading edge phase control
Mounting Box Depth (Min)	35mm
Terminal Capacity	1 x 4mm ² / 1 x 2.5mm ² / 3 x 1.5mm ² / 4 x 1mm ²
Terminal Markings	L (Load), 1, 2, C (Live)
Neutral Required	No
Short Circuit Protection	Yes
Overload/Overcurrent Protection	Yes
Thermal Protection	Yes - Thermal resettable fuse
Soft Start	Yes
Power Failure	Previous state recall
Memory	Non volatile
Min/Max Level Setting	Yes - Following a defined procedure
Driving Mode	Yes - TE & LE mode Change following a defined procedure
Product Dimensions	48mm x 28mm x 15.9mm
Climate Range	0°C to 40°C, Humidity 0% to 95% non-condensing
Recommended Location	Indoor use only
Maximum Installation Altitude	2000m
IP Rating	IP2XD
Trademarks	Enkin is a registered trademark and trading name of Trade Ivy Ltd. Registered in England Number: 10809945. Copyright © 2024



Operating Voltage	240V ac
Nominal Operating Frequency	50 Hz
Dimming Technique	Trailing & leading edge phase control
Compliance	BS EN 60669-2-1

Load Symbol	Compatible Loads	Max Load	Min Load
	Dimmable LED lighting	250W TE 100W LE	2W
	240V Incandescent & Halogen lamps	250W TE 100W LE	2W
	Low voltage lighting with electronic transformers	250W TE 100W LE	2W

Multi-Gang Switch De-Rating Chart				
1 Gang	2 Gang	3 Gang	4 Gang	5 Gang
250W	212W	175W	137W	100W

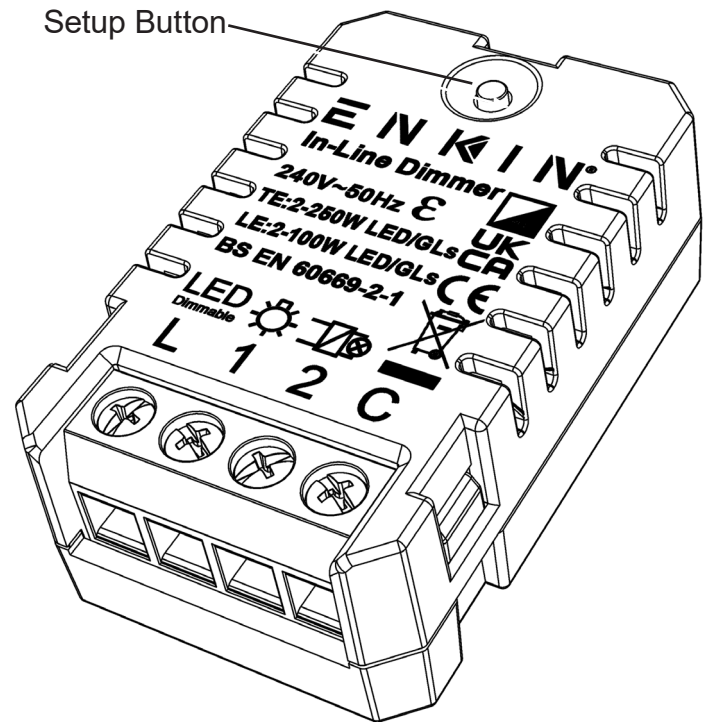

WIRING EXAMPLES

WIRING DIAGRAM

Single Retractive Switch

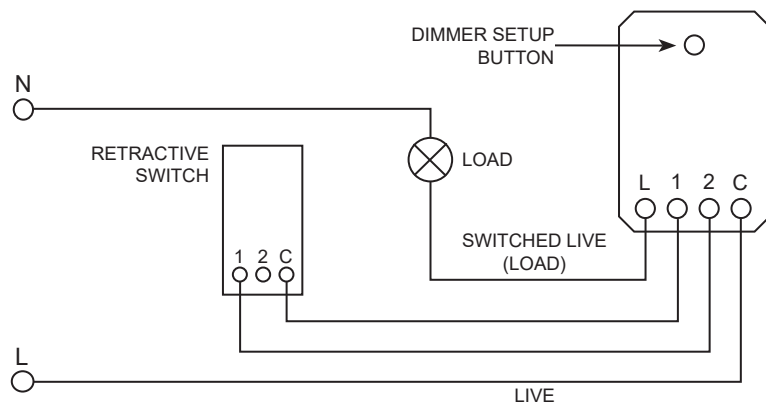

WIRING DIAGRAM

Multiple Retractive Switches

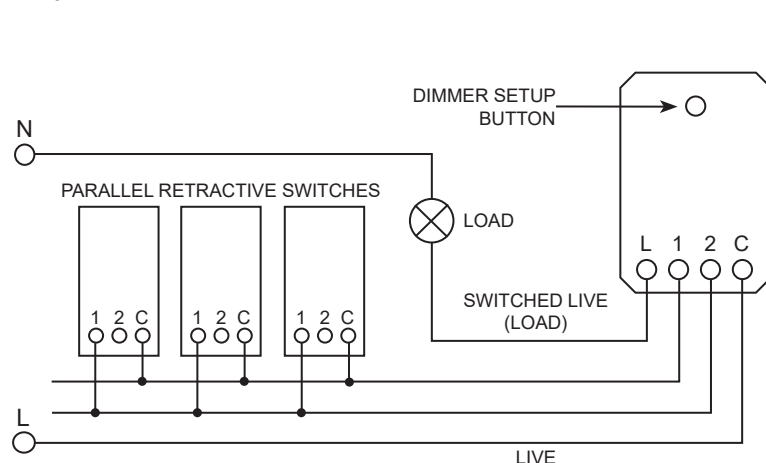

OPERATING INSTRUCTIONS

On/Off and dimming is achieved with a connected retractive switch, or multiple (parallel) retractive switches, please refer to example circuit diagrams on the other side of this document for details.

A fast click of the retractive switch will turn the lamp (or Load) on and off, holding the switch will alternately dim the lamp up or down, release the switch when desired lamp brightness has been achieved.

NOTE: This product is supplied with a minimum level already set, if this does not work well with your situation, please perform a Factory Reset before setting a minimum level to suit your setup.

The minimum/maximum level and dimming mode can be manually adjusted by following the procedures below.

SETTING THE MINIMUM LEVEL

1. Whilst on, adjust dimmer to your desired minimum brightness.
2. Push the setup button 3 times within 2 seconds.
3. The LEDs will step up and down in brightness once to confirm the setting has been saved.

SETTING THE MAXIMUM LEVEL

1. Whilst on, adjust dimmer to your desired maximum brightness.
2. Push the setup button 5 times within 3 seconds.
3. The LEDs will step up and down in brightness once to confirm the setting has been saved.

FACTORY RESET FOR MIN/MAX BRIGHTNESS

Please note this factory reset will reset all the min and max brightness settings.

1. Whilst on, push the rear setup button 7 times within 5 seconds.
2. The LEDs will step up and down in brightness three times to confirm that the min/max setting has been cleared.

CHANGING THE DIMMING MODE

The default mode of the dimmer is Trailing Edge, but it can be put into Leading Edge if required. Please ensure that you know the correct mode for your lamp.

1. Whilst on, push the setup button 9 times within 5 seconds.
2. The LEDs will step up and down in brightness twice to confirm the setting has been changed to Leading Edge mode.

NOTE:

To switch back to Trailing Edge mode, just repeat the process again, the LEDs will step up and down once to show the dimmer is back in Trailing Edge mode.