

INSTRUCTIONS

LT-SH-11-WLT353 (all finishes)

Bulb Fitting: E27, Max. 40W, 220-240V~50Hz



IMPORTANT! Please read these instructions fully before attempting to fit this product, refer to reverse of these instructions to understand all symbols.

WARNING: ENSURE THE ELECTRICAL SUPPLY TO THE WIRES YOU ARE WORKING ON IS SHUT OFF COMPLETELY; EITHER BY REMOVING THE FUSE OR TURNING OFF THE CIRCUIT BREAKER. TURNING THE POWER OFF USING THE LIGHT SWITCH IS INSUFFICIENT PROTECTION AGAINST ELECTRIC SHOCK.

NOTE: These important safeguards and instructions are not meant to cover all possible conditions or situations that may occur. It must be understood that common sense, caution, and care, are factors that must be supplied by the person(s) installing this product.

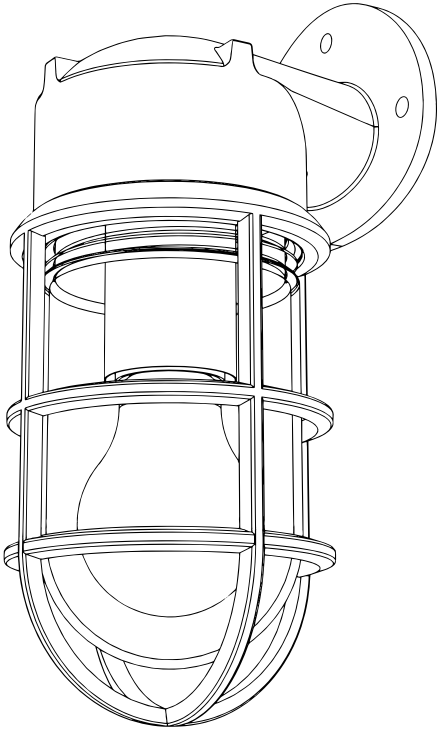

IMPORTANT: Electric current can kill, always turn off the electricity supply before fitting. It is essential that this light is fitted by an experienced professional.

IMPORTANT: This light must be fixed to a secure structure that will safely bear its weight and from which it cannot become loose. The supplied fixings will not be suitable for all situations, please ensure you use the correct fixings for your building fabric. Please use the correct electric cable for the power supply and location.

IMPORTANT: Before fitting, if the product appears damaged in any way, do not use and refer to the retailer. This light is manufactured using traditional methods and moulds and as such each item is unique and subtle variations can naturally occur. Care must be taken when fitting this light to ensure it is not damaged. Gloves are provided to prevent marking, brass will naturally darken with age, to prevent this please polish regularly with a suitable polish.

WARNING: Plastic bags can be dangerous, to avoid danger of suffocation keep them away from children or babies. Please dispose of packaging responsibly and recycle product at end of life.

FITTING INSTRUCTIONS

Step 1: Turn off electric supply.

Step 2: Remove Cage and Glass from Light Fitting by turning cage anti-clockwise when viewed from below. Be careful not to damage the glass in the process.

Step 3: Connect external supply to light cable in Wall Plate using the connection block provided. Please ensure correct connection of LIVE (L) TO LIVE (BROWN), NEUTRAL (N) TO NEUTRAL (BLUE) and EARTH (⊕) TO EARTH (GREEN/YELLOW). If you are fixing this Light Fitting external location or an area where the light's IP rating is critical to protect against water penetration, you need to ensure that your connection to the power supply is watertight.

Step 4: Fix Light Fitting to the wall through the Fixing Holes using suitable fixings the securely hold the weight of the light. Ensure light is secure.

Step 5: Fit LED bulb/lamp - E27, MAX 40W to the bulb holder in the light fitting.

Step 6: Carefully reassemble light with Glass Dome and Protective Cage, ensuring a tight seal is achieved with all fixings.

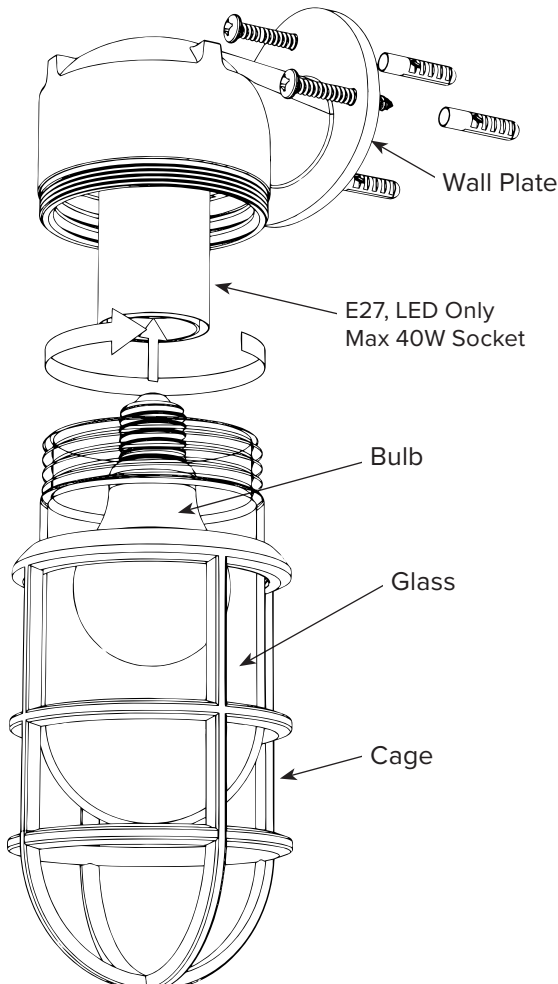

Additional information
can be found at soholighting.com
or on request via email: info@soholighting.com



GENERAL SAFETY INFORMATION

WARNING! Danger of electric shock!

Defective electrical installation may cause electric shock.



Electrical installations of products with connection terminals for installation on the mains connection line are to be performed by an electrician! Please note! Before proceeding with any electrical installation, the mains connecting cable must be de-energized (fuse turned off). Please note the following symbols and safety information in order to avoid damage caused by incorrect assembly or use:

Changes: Do not make any changes to the lamp or its connecting cable. Unless specified otherwise.

Commissioning: Do not operate product if any cable or connecting cable show visible signs of damage.

Changing illuminant (lamp/bulb): Before replacing the illuminant ensure that the light is not live! Lights and illuminants may become hot in operation. Allow them to cool before a change. Use only the illuminant specified on the light. The maximum power per illuminant may not be exceeded. Also, if applicable, the prescribed illuminant type must be observed.

Care advice: Only clean product when turned off, do not allow any moisture into connecting areas or on current-carrying parts. Cleaning agents may cause staining.

	Protection class 1: For products with this symbol connect the mains supply side with the yellow/green (earth) protective conductor to the protective earth terminal.		The product conforms to required CE standards.
	Protection class 2: For products with this symbol no protective conductor is necessary for safe operation.		The LED light source cannot be replaced.
	Protection class 3: Only operate products with this symbol with Safety Extra Low Voltage (SELV). Only connect to SELV circuits.		The control gear cannot be replaced.
	Minimum distance: This symbol explains the minimum distance of the illuminant to the illuminated, normally flammable surface.		The light source can only be replaced by a professional.
	Luminaire not suitable for covering with thermally insulated material: Follow the minimum clearance distance guidance in the instructions. WARNING: RISK OF OVERHEATING OR FIRE IF THE CLEARANCE IS COMPROMISED.		The LED light source can only be replaced by a professional.
	WEEE Waste Disposal: To ensure products are recycled without hazard to the environment, DO NOT dispose of electrical or electronic products carrying this symbol as household waste. Contact your local council for collection and recycling schemes in your area.		The control gear can only be replaced by a professional.
	Recessed luminaire not suitable for mounting in normally flammable surfaces: Do not install products with this symbol on flammable/combustible surfaces.		The light source can be replaced by an end user.
	Replace any cracked protective shield/glass: Check product and replace any cracked protective shield/glass.		The LED light source can be replaced by an end user.
	Indoor use only: This symbols means the product has no protection against ingress of water. Only install in dry, closed indoor locations.		The control gear can be replaced by an end user.
	Luminaire only designed to be used with GU10 LED, self-shielded tungsten halogen or self-shielded metal halide lamp.		This product contains (a) light source(s) of energy efficiency class A, B, C, D, E, F or G depending on which letter is displayed.
	Warning electrical shock.	IP44	Ingress Protection: Protected against solid objects greater than 1mm in size. Protected against water splashing from any angle. Product is suitable for bathroom zones 2 & 3.
	Caution: Observe warnings and safety information.	IP65	Ingress Protection: Protected against access to hazardous parts. Dust-tight. Protected against powerful water jets from any angle. Product is suitable for outdoor and bathrooms.
	The product conforms to required UKCA standards.	IP68	Ingress Protection: Protected against access to hazardous parts. Dust-tight. Product protected against submersion as specified, e.g. continuous submersion, up to 3M.