

20A 2 Gang 2 Way Toggle Switch - Flat Plate

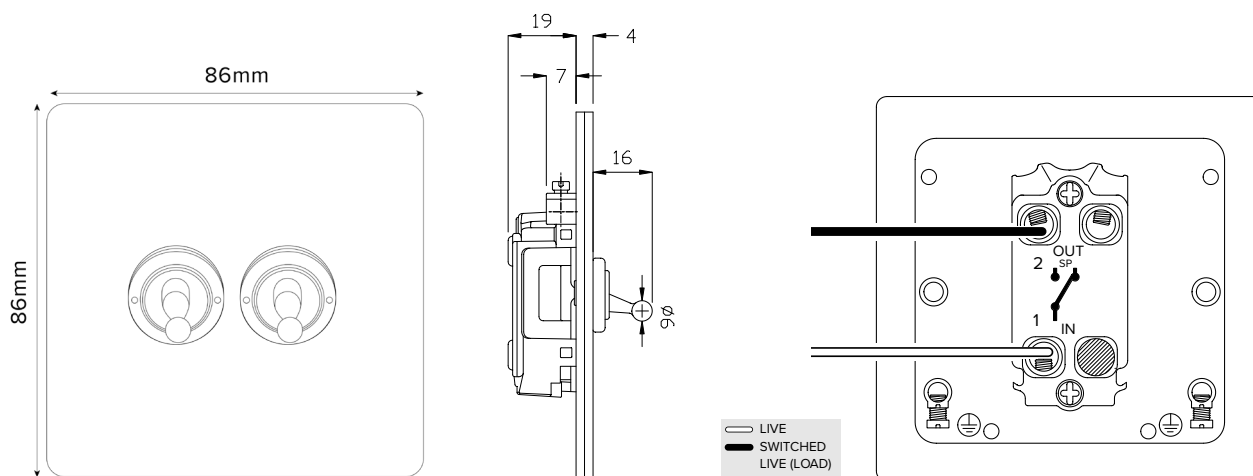

TECHNICAL SPECIFICATION

Standard(s)	BS EN 60669-1
Voltage Rating	20 Amp, 250V~ (20AX – no derating for inductive or fluorescent loads)
Contact Gap	Normal Gap
Mounting Box Depth (Min)	35mm
Terminal Capacity	3 x 2.5mm ² , 2 x 4.0mm ² , 1x 6.0mm ²
Earth Terminal Capacity	3 x 2.5mm ² , 2 x 4.0mm ² , 1x 6.0mm ²
Fixing Centres	60.3mm
Size	86mm x 86mm x 4mm (Plate thickness - 2mm)
Product Class 1	Face plate must be earthed
Ambient Operating Temperature	-5° to +40°C
Recommended Location	Internal Use Only
Maximum Installation Altitude	2000m
IP Rating	IP2XD
Switched Poles	Single
Mains Frequency	50hz - 60hz
Contact Gap Minimum	3mm
Trademarks	The Soho Lighting Company is a registered trade mark number: UK00003313349, EU017906396, Date: 25 May 2018